

KRS Series

Submersible Dewatering Pumps

OPERATION MANUAL

INTRODUCTION

Thank you for selecting the Tsurumi KRS Series Submersible Dewatering Pumps.

This operation manual explains the product operations and gives important precautions regarding its safe use. In order to use the product to maximum benefit, be sure to read the instructions thoroughly and follow them carefully.

To avoid accident, do not use the pump in any way other than as described in this operation manual. Note that the manufacturer cannot be responsible for accidents arising because the product was not used as prescribed. After reading this operation manual, keep it nearby as a reference in case questions arise during use.

When lending this product to another party, always be sure to include this operation manual as well.

If this operation manual should become lost or damaged, ask your nearest dealer or Tsurumi representative for another copy.

Every effort has been made to ensure the completeness and accuracy of this document. Please contact your nearest dealer or Tsurumi representative if you notice any possible error or omission.

The contents of this document may not be copied in whole or in part without the express permission of Tsurumi Manufacturing Co., Ltd.

CONTENTS

1. BE SURE TO READ FOR YOUR SAFETY	1
2. NAME OF PARTS	4
3. PRIOR TO OPERATION	5
4. INSTALLATION	7
5. ELECTRICAL WIRING	9
6. OPERATION.....	10
7. MAINTENANCE AND INSPECTION.....	13
8. DISASSEMBLY AND REASSEMBLY	15
9. TROUBLESHOOTING	18

1 BE SURE TO READ FOR YOUR SAFETY

Be sure to thoroughly read and understand the SAFETY PRECAUTIONS given in this section before using the equipment in order to operate the equipment correctly.

The precautionary measures described in this section are intended to prevent danger or damage to you or to others. The contents of this manual that could possibly be performed improperly are classified into two categories: **⚠ WARNING**, and **⚠ CAUTION**. The categories indicate the extent of possible damage or the urgency of the precaution. Note however, that what is included under **⚠ CAUTION** may at times lead to a more serious problem. In either case, the categories pertain to safety-related items, and as such, must be observed carefully.

- **⚠ WARNING** : Operating the equipment improperly by failing to observe this precaution may possibly lead to death or injury to humans.
- **⚠ CAUTION** : Operating the equipment improperly by failing to observe this precaution may possibly cause injury to humans and other physical damage.
- **NOTE** : Gives information that does not fall in the WARNING or CAUTION categories.
- **Explanation of Symbols:**



: The \triangle mark indicates a WARNING or CAUTION item. The symbol inside the mark describes the precaution in more detail ("electrical shock", in the case of the example on the left).



: The \odot mark indicates a prohibited action. The symbol inside the mark, or a notation in the vicinity of the mark describes the precaution in more detail ("disassembly prohibited", in the case of the example on the left).



: The \bullet mark indicates an action that must be taken, or instructs how to perform a task. The symbol inside the mark describes the precaution in more detail ("provide ground work", in the case of the example on the left).

PRECAUTIONS TO THE PRODUCT SPECIFICATIONS

⚠ CAUTION











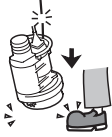
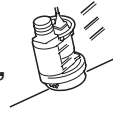
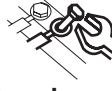
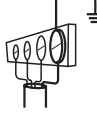



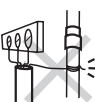





● Do not operate the product under any conditions other than those for which it is specified. **Failure to observe the precaution can lead to electrical leakage, electrical shock, fire, water overflow or other problems.**







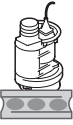









PRECAUTIONS DURING TRANSPORT AND INSTALLATION





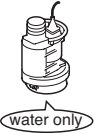

⚠ WARNING

	<p>● When transporting the product, pay close attention to its center of gravity and mass. Use an appropriate lifting equipment to lift the unit. Improper lifting may result in the fall of the product which could cause damage of the product or human injury.</p> 		<p>● Install the product properly in accordance with this instruction manual. Improper installation may result in electrical leakage, electrical shock, fire, water leakage, or injury.</p> 
	<p>● Electrical wiring should be performed in accordance with all applicable regulations in your country. Absolutely provide a dedicated earth leakage circuit breaker and a thermal overload relay suitable for the product (available on the market). Imperfect wiring or improper protective equipment can lead to electrical leakage, fire, or explosion in the worst case.</p> 		<p>● Provide a secure grounding dedicated for the product. Never fail to provide an earth leakage circuit breaker and a thermal overload relay in your starter or control panel (Both available on the market). If an electrical leakage occurs by due to a product failure, it may cause electrical shock.</p> 











 CAUTION	
 <ul style="list-style-type: none"> ● Be sure to provide a ground wire securely. Do not connect the ground wire to a gas pipe, water pipe, lightning rod, or telephone ground wire. Improper grounding could cause electrical shock. 	 <ul style="list-style-type: none"> ● Attach a hose securely to the hose coupling. Imperfect connection of hose could cause water leakage which may result in the damage of nearby walls, floors, and other equipment. 
 <ul style="list-style-type: none"> ● Do not scratch, fold, twist, make alterations, or bundle the cable, or use it as a lifting device. The cable may be damaged, which may cause electrical leakage, short-circuit, electrical shock, or fire. 	 <ul style="list-style-type: none"> ● Do not use the cabtyre cable if it is damaged. Connect every conductor of the cabtyre cable securely to the terminals. Failure to observe this can lead to electrical shock, short-circuit, or fire. 
 <ul style="list-style-type: none"> ● When the product will be carried by hand, decide the number of persons considering the mass of the product. When lifting up the product, do not attempt to do it by simply bowing from the waist. Use the knees, too, to protect your back. 	 <ul style="list-style-type: none"> ● Use the handle when installing or carrying the pump. Never use the cable to carry or to suspend. Doing so may damage the cable which could cause electrical leakage, short circuit, or fire. 
 <ul style="list-style-type: none"> ● This pump is neither dust-proof nor explosion-proof. Do not use it at a dusty place or at a place where toxic, corrosive or explosive gas is present. Use in such places could cause fire or explosion. 	 <ul style="list-style-type: none"> ● Allow the pump to suck as few foreign object as possible. If there is a risk that the pump could be buried under the sediment, place it on a solid base like concrete block. Failure to do so may result in breakdown of the pump and could cause electrical leakage or short circuit. 
 <ul style="list-style-type: none"> ● If a hose is used for the discharge line, take a measure to prevent the hose from shaking. If the hose shakes, you may be wet or injured. 	

PRECAUTIONS DURING TEST OPERATION AND OPERATION



 WARNING	
 <ul style="list-style-type: none"> ● Never try to operate the pump if somebody is present in the pump sump. If an electrical leakage occurs, it can cause electrical shock. 	 <ul style="list-style-type: none"> ● When changing power connection is needed to correct the direction of rotation, be sure to turn off the power supply (earth leakage circuit breaker, etc.), and perform the work after making sure that the impeller has stopped completely. Failure to do so may lead to electrical shock, short-circuit, or injury. 
 <ul style="list-style-type: none"> ● Never start the pump while it is suspended, as the unit may jerk and could lead to injury. 	
 CAUTION	
 <ul style="list-style-type: none"> ● Do not operate the product under any voltage other than described on the nameplate with the voltage tolerance limit within $\pm 5\%$. If it is operated with a generator, it is strongly suggested not to operate other equipment with the same generator. Failure to observe this caution may cause malfunction and breakdown of the product, which may lead to electrical leakage or electrical shock. 	 <ul style="list-style-type: none"> ● Do not touch the product with bare hands during or immediate after the operation, as the product may become very hot during operation. Failure to observe this caution may lead to be burned. 
 <ul style="list-style-type: none"> ● Do not use the product in a liquid other than water. Use in oil, salt water or organic solvents will damage it, which may lead to electrical leakage or electrical shock. 	 <ul style="list-style-type: none"> ● Do not run the product dry or operate it with its gate valve closed, as doing so will damage the product, which may lead to electrical leakage or electrical shock. 

 CAUTION	
	<p>● Do not use the product for hot or warm liquid over 40°C, as doing so will damage the product, which may lead to electrical leakage or electrical shock.</p> 
	<p>● Do not allow foreign object (pin, wire, etc.) to enter the suction inlet of the pump. Failure to observe this caution could cause it to malfunction or to operate abnormally, which may lead to electrical leakage or electrical shock.</p> 
	<p>● When the product will not be used for an extended period, be sure to turn off the power supply (earth leakage circuit breaker, etc.). Deterioration of the insulation may lead to electrical leakage, electrical shock, or fire.</p> 



PRECAUTIONS DURING MAINTENANCE AND INSPECTION

 WARNING	
	<p>● Absolutely turn off the power supply or disconnect the plug before starting maintenance or inspection. Do not work with wet hands. Failure to observe these cautions may lead to electrical shock or injury.</p> 
	<p>● In case any abnormality (excessive vibration, unusual noise or odor) is found in the operation, turn the power off immediately and consult with the dealer where it was purchased or Tsurumi representative. Continuing to operate the product under abnormal conditions may result in electrical shock, fire, or water leakage.</p> 
	<p>● Do not disassemble or repair any parts other than those designated in the operation manual. If repairs are necessary in any other than the designated parts, consult with the dealer where it was purchased or Tsurumi representative. Improper repairs can result in electrical leakage, electrical shock, fire, or water leakage.</p> 
 CAUTION	
	<p>● After reassembly, always perform a test operation before resuming use of the product. Improper assembly can result in electrical leakage, electrical shock, fire, or water leakage.</p> 

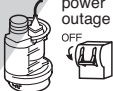
PRECAUTION TO POWER OUTAGE

 WARNING	
	<p>● In case of power outage, turn off the power supply. The product will resume operation when the power is restored, which presents serious danger to people in the vicinity.</p> 

OTHER PRECAUTION

 CAUTION	
	<p>● Never use the product for potable water. It may present a danger to human health.</p> 

2 NAME OF PARTS

■ Example ; KRS2-C6

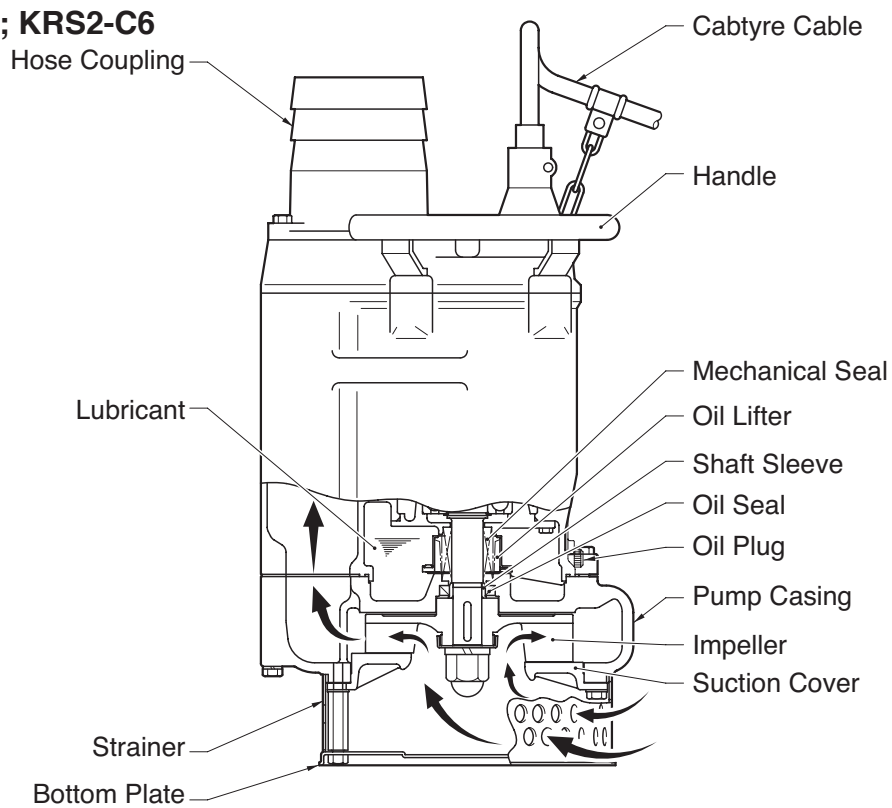

Note: *The above diagram is typical of the KRS2-C6, but some models may vary slightly in appearance or internal structure.*

■ Example ; KRS1022

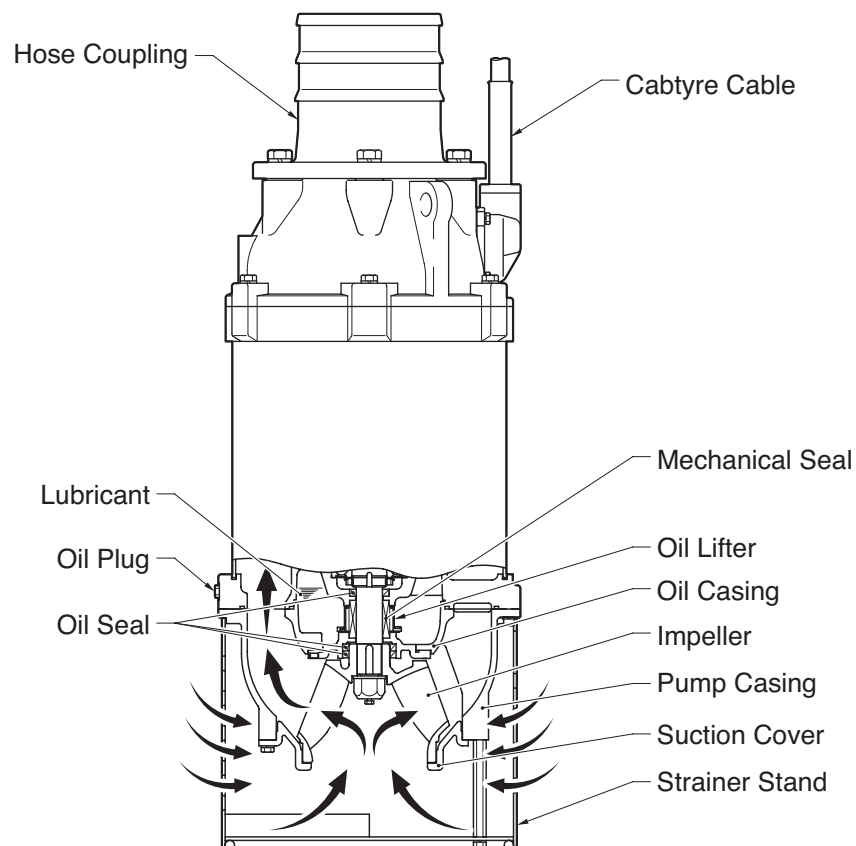

Note: *The above diagram is typical of the KRS1022, but some models may vary slightly in appearance or internal structure.*

3 PRIOR TO OPERATION

When the pump is delivered, first perform the following checks.

Inspection

While unpacking, inspect the product for damage during shipment, and make sure all bolts and nuts are tightened properly.

Specification Check

Check the model number to make sure it is the product that was ordered. Be certain it is the correct voltage and frequency.

Example of nameplate

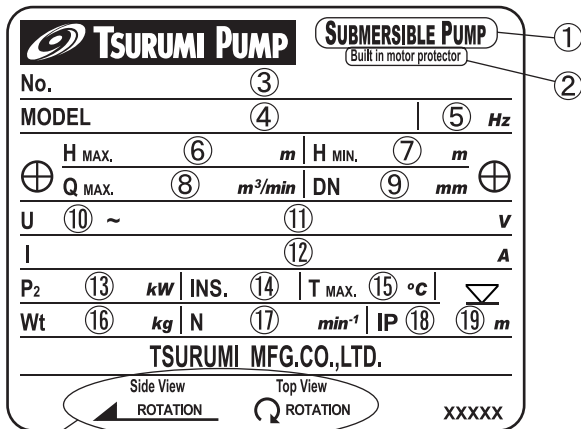

1	Submersible pump	11	Rated voltage
2	Built in motor protector	12	Rated current
3	Serial number	13	Rated output power
4	Model	14	Insulation class
5	Frequency	15	Max. liquid temperature
6	Max. total head	16	Weight without cable
7	Min. total head	17	Speed of rotation
8	Max. flow rate	18	IP degree of protection
9	Discharge bore	19	Max. immersion depth
10	Phase	20	Direction of rotation

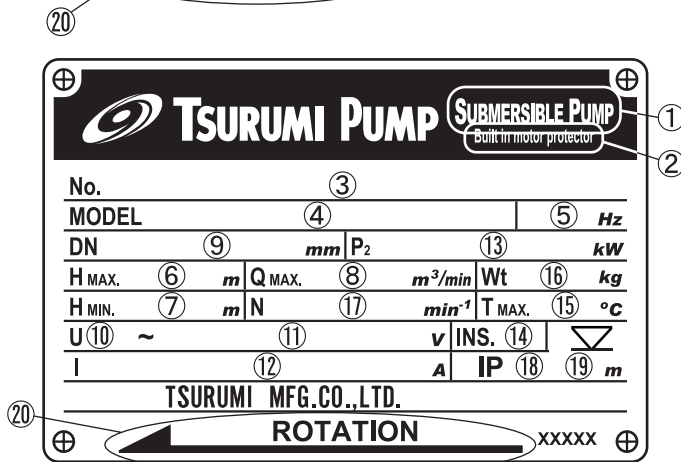

Note: If you discover any damage or discrepancy, please contact with the Tsurumi dealer from whom you purchased the product or the nearest Tsurumi representative office.

Accessory Check

Verify that all accessory items are included in the package.

- Operation Manual 1

Note: If you discover any damage or discrepancy in the product, please contact the dealer where this equipment was purchased or the Tsurumi sales office in your area.

Product Specifications



CAUTION

Do not operate this product under any conditions other than those for which it is specified. Failure to observe this precaution can lead to electrical shock, electrical leakage, fire, water leakage or other problems.

Major Standard Specifications

Fluid	Property	Rain water, Ground water, Sand carrying water ; 0 ~ 40°C
Pump	Impeller	Semi-Open-Type, Close-Type (KRS63/85.5 , KRS1022)
	Shaft Seal	Double Mechanical Seal
	Bearing	Shielded Ball Bearing
Motor	Specification	Dry type Submersible Induction Motor 4-Pole
	Insulation	Class E, B and F
	Protection System	Circle Thermal Protector
	Lubricant	Turbine oil VG32 (non-additive)
Discharge Connection		Hose Coupling

Standard specifications (50/60Hz)

Model	Bore (mm) (inch)	Phase	Starting Method	Output (kW)	Max Head (m) (feet)	Max Capacity (m ³ /min) (GPM)	Weight (kg)
KRS2-C3/A3	80	3	Direct-on-Line	2.2	13.1	1.10 / 1.04	72
	3				43	- / 275	
KRS-43	100	3	Direct-on-Line	3.0	14.8 / 15.0	1.82 / 1.76	95
	4				- / 49	- / 465	
KRS-63	150	3	Direct-on-Line	3.0	8.0	3.25 / 3.15	97
	6				26	- / 832	
KRS2-D3/B3	80	3	Direct-on-Line	3.7	17.5	1.40 / 1.45	91/89
	3				57	- / 383	
KRS2-C4/A4	100	3	Direct-on-Line	3.7	14.0	1.67 / 1.70	88
	4				46	- / 449	
KRS2-D4/B4	100	3	Direct-on-Line	5.5	20.0	2 / 1.95	98/95
	4				66	515	
KRS-65.5	150	3	Direct-on-Line	5.5	17.0	3.18 / 3.20	118
	6				56	- / 845	
KRS-85.5	200	3	Direct-on-Line	5.5	10.0 / 10.8	4.90 / 5	126
	8				- / 35	- / 1321	
KRS2-C6/A6	150	3	Direct-on-Line	7.5	19.6 / 21.0	2.85 / 3.17	130
	6				- / 69	- / 837	
KRS2-69	150	3	Direct-on-Line	9.0	21.0 / 21.2	4.25 / 4.00	155
	6				- / 70	- / 1057	
KRS2-89	200	3	Direct-on-Line	9.0	15.0	5.30 / 5.50	175
	8				49	- / 1453	
KRS2-D6/B6	150	3	Direct-on-Line	11	22.0 / 23.0	3.70 / 3.60	158/150
	6				- / 75	- / 951	
KRS2-8S	200	3	Direct-on-Line	11	17.5 / 18.0	5.50	174
	8				- / 59	1453	
KRS815	200	3	Direct-on-Line	15	21.5 / 23.0	6.40 / 6.30	240
	8				- / 75	- / 1664	
KRS819	200	3	Direct-on-Line	18.5	29.0	5.50 / 5.35	360
	8				95	- / 1413	
KRS822	200	3	Direct-on-Line	22	34.8 / 34.5	5.30	380
	8				- / 113	1400	
KRS822L	200	3	Direct-on-Line	22	26.0 / 24.5	5.90 / 6.30	380
	8				- / 80	- / 1664	
KRS1022	250	3	Direct-on-Line	22	12.2	12.00	390
	10				40	3170	

Note: The weight (mass) given above is the operating weight of the pump itself, not including the cable.

4 INSTALLATION



CAUTION

- Do not use this pump in liquids other than water, such as oil, salt water, or organic solvents.
- Use with a power supply voltage tolerance within $\pm 5\%$ of the rated voltage.
- Do not use in water temperatures outside the range of $0 \sim 40^{\circ}\text{C}$, which can lead to failure, electrical leakage or shock.
- Do not use in the vicinity of explosive or flammable materials.
- Use only in fully assembled state.

Note: Consult your local dealer or Tsurumi representative before using with any liquids other than those indicated in this document.

Maximum allowable water pressure



CAUTION

Do not use at greater than the water pressure shown below, which can damage the pump resulting in electrical leakage and electrical shock.

Model	Maximum allowable water pressure
Model with output 11 kW or less	0.3 MPa (3 kgf/cm ²) - discharge pressure used
Model with output above 15 kW	0.4 MPa (4 kgf/cm ²) - discharge pressure used

Preparing for installation

Before installing the pump at a work site, you will need to have the following tools and instruments ready:

- Insulation resistance tester
- AC voltmeter
- AC ammeter (clamp-on type)
- Bolt and nut tighteners
- Power supply connection tools (screwdriver or box wrench)

Note: Please read also the instructions that come with each of the test instruments.

Checks to make before installation

Use the megohmmeter to measure the motor insulation resistance between the cabtyre cable plug tips and ground lead (Green or Green/Yellow).

Note: The reference insulation resistance (20M Ω or greater) is the value when the pump is new or has been repaired. For the reference value after installation, see below at section "7.Maintenance and Inspection".

Precautions in installation



WARNING

- When installing the pump, pay close attention to its center of gravity and weight. If it is not lowered into place correctly, it may fall and be damaged or cause injury.
- When transporting the pump by hand, be sure to employ manpower commensurate with the weight of the pump. To avoid back injury when lifting the pump, bend the knees to pick it up rather than bending your back only.



CAUTION

Do not under any circumstances install or move the pump by suspending it from the cabtyre cable. The cable may be damaged, causing electrical leakage, shock, or fire.

- (1) Attach the hose to the hose coupling as far as it will go, then fasten it securely with the hose band.

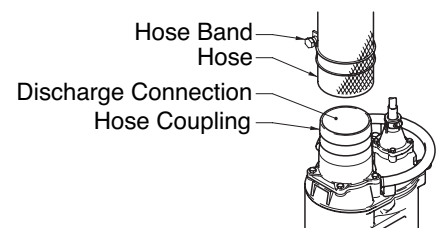

- (2) Avoid dropping the pump or other strong impact. Lift the pump by holding it firmly with the hands or by attaching a rope or chain to the handle.

Note: *On Cabtyre cable handling, see below Electrical Wiring.*

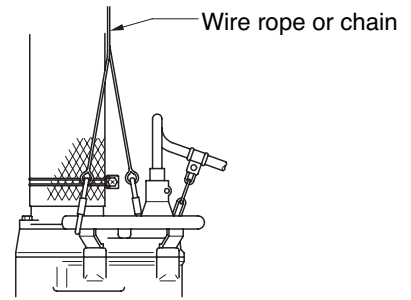

- (3) Install the pump in a location with sufficient water level, where water collects readily.

Note: *The "Operating water level" chart below shows the water level necessary for operation. The tip of the hose (discharge end) should be located higher than the water surface. If the end of the hose is submerged, water may flow back to the pump when the pump is stopped; and if the hose end is lower than the water surface, water may overflow when the pump is turned off.*

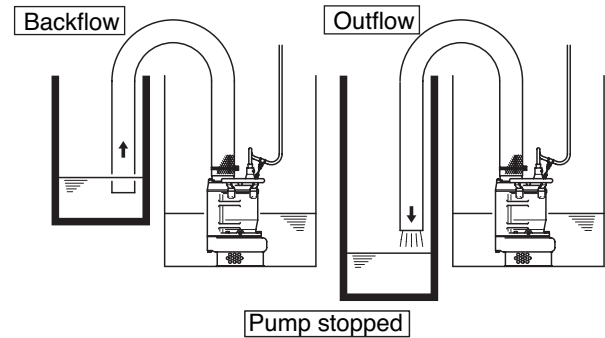

- (4) The hose should be run as straight as possible, since excessive bending will hinder the water flow, preventing sufficient lift, and can even cause the hose to become clogged with earth. If the hose is crimped near the pump, air can become trapped in the pump and cause idle running.

CAUTION

- If large quantities of earth are sucked up, damage resulting from friction in the pump can lead to electrical leakage and shock.
- When the pump is installed at a work site, make sure the hose is connected in such a way as to ensure proper drainage. Otherwise water may leak out and cause damage to surrounding walls or flooring, or to equipment.

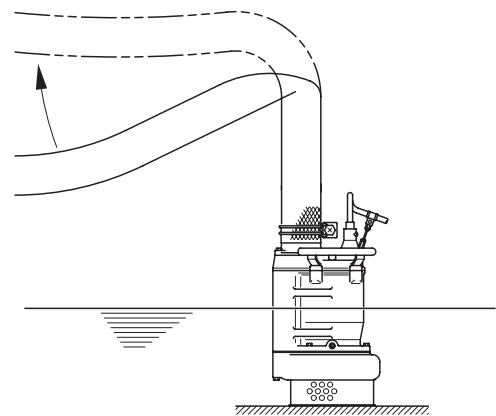

- (5) Use the pump in the upright position. To prevent the pump from becoming submerged in mud, mount it on a block or other firm base if necessary.

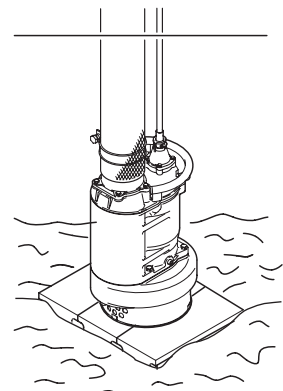

5 ELECTRICAL WIRING

Performing electrical wiring



WARNING

- Electrical wiring should be performed by a qualified person in accord with all applicable local regulations. Failure to observe this precaution not only risks breaking the law but is extremely dangerous.
- Incorrect wiring can lead to electrical leakage, electrical shock or fire.
- Absolutely provide a dedicated earth leakage circuit breaker and a thermal overload relay suitable for the pump (available on the market). Failure to follow this warning can cause electrical shock or explosion when the product fails or an electrical leakage occurs.

Operate well within the capacity of the power supply and wiring.

Grounding



WARNING

Do not use the pump without first grounding it properly. Failure to ground it can lead to electrical shock from an electrical leak or pump malfunction.



CAUTION

Do not attach the grounding wire to a gas pipe, water pipe, lightning arrestor or telephone grounding wire. Improper grounding can result in electrical shock.

Cabtyre cable



CAUTION

- If it is necessary to extend the cabtyre cable, use a core size equal to or larger than the original. This is necessary not only for avoiding a performance drop, but to prevent cable overheating which can result in fire, electrical leakage or electrical shock.
- If a cable with cut insulation or other damage is submerged in the water, there is a danger of water seeping into the motor causing a short. This may result in damage to the pump, electrical leakage, electrical shock, or fire.
- Be careful not to let the cabtyre cable be cut or become twisted. This may result in damage to the pump, electrical leakage, electrical shock, or fire.
- If it is necessary to submerge the connection leads of the cabtyre cable in water, first seal the leads completely in a molded protective sleeve, to prevent electrical leakage, electrical shock, or fire.

Do not allow the cabtyre cable leads to become wet.

Make sure the cable does not become excessively bent or twisted, and does not rub against a structure in a way that might damage it.

Connecting the cabtyre cable



WARNING

Before connecting leads to the terminals, make certain the power supply is turned off (circuit breaker, etc.), to avoid electrical shock, shorting, or unexpected starting of the pump, leading to injury.



CAUTION

Do not use the pump if the cabtyre cable is worn or damaged, which can result in electric shock, shorting, or fire.

Connect the leads of cabtyre cable to the control panel terminals as shown in the diagram, being careful not to let the leads become twisted together.

Direct on line

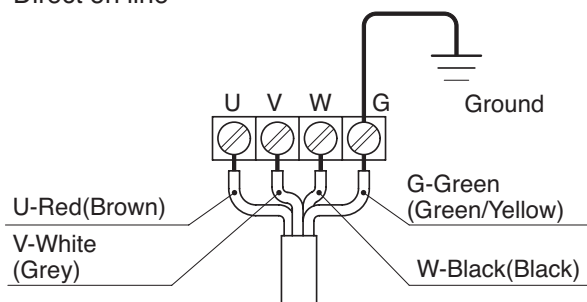

Electrical circuit diagrams

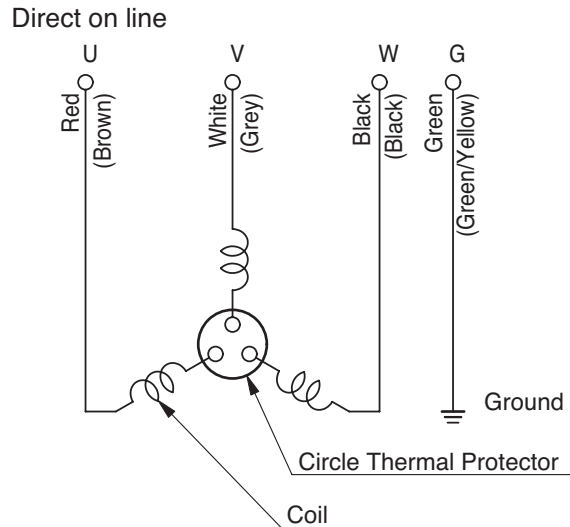

6 OPERATION

Before starting

- (1) Make sure once again that the product is of the correct voltage and frequency rating.



CAUTION

Using the product at other than rated voltage and frequency will not only lower its performance but may damage the product.

Note: Confirm the rated voltage and frequency on the model name plate.

- (2) Confirm the wiring, supply voltage, circuit breaker capacity, and motor insulation resistance.

Reference insulation resistance = 20 MΩ or greater

Note: The reference insulation resistance (20MΩ or greater) is the value when the pump is new or has been repaired. For the reference value after installation, see below at section "7.Maintenance and Inspection "

- (3) The setting on the circuit breaker or other overload protector should be made in accord with the rated current of the pump.

Note: See the model name plate on the pump for its rated current.

- (4) When powering the pump with a generator, do not share the generator with other equipment.

Test operation



WARNING

- Never operate the pump while it is suspended in the air. The recoil may result in injury or other major accident.
- Never start the pump when people are standing next to it. An electrical leak can result in electrical shock.

- (1) Run the pump for a short time(1~2 seconds) to check the direction of rotation. The rotation is correct if the pump recoil direction is counter-clockwise.



CAUTION

Always perform the rotation check in air, not while the pump is submersed. Running the pump in reverse direction while submersed may damage the pump, resulting in electrical leakage or electrical shock.

- (2) If the direction is reversed, correct it using the countermeasure shown below.



WARNING

Before changing the connections to correct the rotation, be sure to turn off the power supply (circuit breaker), and make sure the impeller has stopped completely, to avoid electrical shock or shorting.

COUNTERMEASURE

(Direct-on-line start models):
Interchange connections between any two of the three leads U, V, or W.

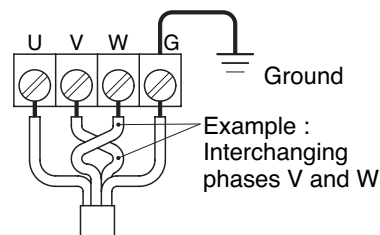

- (3) Run the pump for a short time (3~10minutes) and confirm the following.
Using an ammeter(clamp-on type), measure the operating current at the U, V, and W phase leads on the terminal strip.

COUNTERMEASURE

If the operating current exceeds the rated value, pump motor overload may be a cause. Make sure the pump has been installed under proper conditions as described in the section on Installation.

Using an AC voltmeter(tester), measure voltage at the terminal strip.

- Supply voltage tolerance : within $\pm 5\%$ of rated voltage.

COUNTERMEASURE

If the supply voltage is outside the variation, possible causes are the power supply capacity or an inadequate extension cable. Look again at Electrical Wiring and make sure the conditions are proper.



CAUTION

In case of very excessive vibration, unusual noise or odor, turn off the power immediately and consult with your nearest dealer or Tsurumi representative. Continuing to operate the pump under abnormal conditions may result in electrical shock, fire, or electrical leakage.

- (4) If the test operation turns up no problems, continue with full operation.

Operation



WARNING

- The pump may become very hot during operation. Be careful not to contact the pump accidentally to avoid being burned.
- To avoid serious injury, do not insert a finger or any other object in the pump inlet holes.
- When the pump is not used for an extended period, be sure to turn off the power (circuit breaker, etc.). Deterioration of the insulation may lead to electrical leakage, electrical shock, or fire.
- In case of a power outage, turn off the power to the pump to avoid having it start unexpectedly when the power is restored, presenting serious danger to people in the vicinity.

Pay careful attention to the water level while the pump is operating. Dry operation may cause the pump to malfunction.

Note: See below, "Operating water level" for the water level necessary for operation.

Operation water level



CAUTION

Do not operate the pump below the C.W.L. (Continuous Running Water Level). Failure to observe this condition may result in damage to the pump, electrical leakage or electrical shock.

The table shows the C.W.L. for different output classes. Be careful not to allow the water level to drop below the applicable limit.

Applicable Model	C.W.L. (mm)	Applicable Model	C.W.L. (mm)
KRS2-C3/A3	145	KRS2-69	200
KRS-43	170	KRS2-89	300
KRS-63	300	KRS2-D6	180
KRS2-D3/B3	155	KRS2-B6	175
KRS2-C4/A4	155	KRS2-8S	300
KRS2-D4/B4	155	KRS815	275
KRS-65.5	190	KRS819	345
KRS-85.5	295	KRS822	345
KRS2-C6/A6	175	KRS822L	345
		KRS1022	450

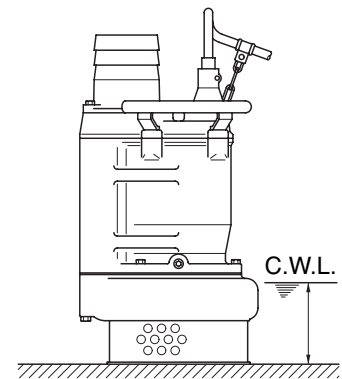

Motor protection system



WARNING

During inspections or repairs, always be sure to turn off the power. Sudden unexpected starting of the pump can cause electrical shock, shorting, or serious injury.



CAUTION

- Always determine the cause of the problem and resolve it before resuming operation. Simply repeating cycles of stopping and restarting will end up damaging the pump.
- Do not continue operation at very low water level, or while the strainer stand is clogged with debris. Not only will performance suffer, but such conditions may cause noise, heavy vibration, and malfunctioning.

Circle Thermal Protector

If an excessive current is detected or the motor overheats, for reasons such as the following, the pump will automatically stop operating regardless of the water level, to protect the motor.

- Change in supply voltage polarity
- Overload
- Open-phase operation or operation under constraint

Note: After the motor protector has tripped, the motor automatically resumes its operation. Therefore, make sure to disconnect the cable from the terminal board or the power outlet, and eliminate the cause of the problem.

Do not operate the pump at unusually low head, or with the impeller clogged with debris. Doing so will not only prevent the pump from attaining its full potential, but may also generate abnormal noise and vibration and damage the pump.

7 MAINTENANCE AND INSPECTION

Regular maintenance and inspections are a necessity for continued efficient functioning of the pump. If any abnormal conditions are noticed, refer to the section "9.Troubleshooting" and take corrective measures immediately. It is recommended that a spare pump be kept ready in case of any problems.

Prior to inspection

WARNING Detach the cabtyre cable from the receptacle or terminals, after making certain the power supply (circuit breaker, etc.) is turned off. Failure to follow this precaution may result in a serious accident from electrical shock or unexpected starting of the pump motor.

- (1) Washing the pump
Remove accumulated matter from the surface of the pump and wash it with clean water. Take special care to remove any debris from the impeller.
- (2) Inspecting the pump exterior
Look for any peeling or chipped paint, and make sure the nuts and bolts are fastened tightly. Any cracks in the surface should be repaired by cleaning that area, drying it and then applying a touchup coating.

Note: *Touchup is not supplied. Note that some kinds of damage or looseness may require that the unit be disassembled for repairs. Please consult with your nearest dealer or Tsurumi representative.*

Regular Inspection

Interval	Inspection Item
EveryDay	<ul style="list-style-type: none"> ■ Measure operating current ● To be below the rated current ■ Measure power supply voltage ● Power supply voltage tolerance (within ±5% of the rated voltage)
Monthly	<ul style="list-style-type: none"> ■ Measuring insulation resistance ● Insulation resistance reference value = 1MΩ min. <i>Note: The motor must be inspected if the insulation resistance is considerably lower than that obtained during the last inspection.</i> ■ Pump inspection ● A noticeable drop in performance may indicate wear in the impeller etc., or else clogging of the strainer stand, etc. Remove the clogged debris, and replace any worn parts.
Semi-yearly	<ul style="list-style-type: none"> ■ Inspection of lifting wire rope or chain ● Replace if damage, corrosion, or wear has occurred to the wire rope or the chain. Remove if foreign object is attaching to it. ■ Inspecting oil ● Check the oil every 6 months or after 3,000 hours of use, whichever comes first. <i>Note: Refer to details of oil inspection and oil change.</i>
Yearly	<ul style="list-style-type: none"> ■ Change oil ● Change the oil every 12 months or after 6,000 hours of use, whichever comes first. <i>Note: Refer to details of oil inspection and oil change.</i> ■ Change mechanical seal <i>Note: Contact the dealer from whom you purchased the equipment, or the Tsurumi sales office in your area to inspect and replace the mechanical seal.</i>
Every 2 to 5 years	<ul style="list-style-type: none"> ■ Overhaul ● The pump must be overhauled even if the pump appears normal during operation. The pump may need to be overhauled earlier if it is used continuously or repeatedly. <i>Note: Contact the dealer from whom you purchased the equipment, or the Tsurumi sales office in your area to overhaul the pump.</i>

Storage

When the pump is out of use for an extended period, wash it and dry it thoroughly, then store it indoors.

Note: *Always run a test operation before putting the pump back into service.*

When the pump is left installed in water, it should be run at regular intervals (about once a week).

Oil inspection and Oil change

WARNING When the pump is tilted for inspecting or changing the oil, pay careful attention to the center of gravity and weight of the pump. When lowering the pump, fasten the wire rope or the chain to the eyebolts provided for this purpose. Failing to lower the pump completely may result in damage or injury if the pump is dropped.

Inspecting Oil

Remove the oil plug and tilt the pump to drain a small amount of oil. If the oil is milky white or has water mixed in with it, the mechanical seal may be faulty. In this case the pump will need to be disassembled and repaired.

Replacing Oil

Remove the oil plug and drain all the oil, then replace it with the specified amount.

Note: Worn oil and other waste products should be disposed of by a qualified agent, in accord with applicable local laws. The oil plug packing and O-ring should be replaced each time the oil is inspected or changed.

Specified Oil : Turbine Oil VG32 (non-additive)

Unit : ml

Applicable Model	Specified Volume	Applicable Model	Specified Volume
KRS2-C3/A3	1200	KRS2-69	2300
KRS-43	1440	KRS2-89	2300
KRS-63	1440	KRS2-D6/B6	2300
KRS2-D3/B3	1850	KRS2-8S	2300
KRS2-C4/A4	1850	KRS815	3200
KRS2-D4/B4	1850	KRS819	6500
KRS-65.5	1960	KRS822	6500
KRS-85.5	1960	KRS822L	6500
KRS2-C6/A6	2300	KRS1022	4000

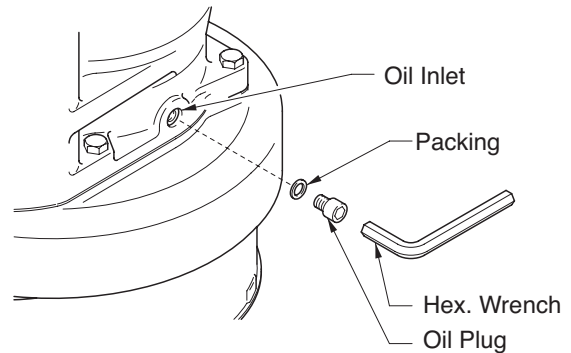

Replacement Parts

The table lists the parts that need to be replaced periodically. Replace these using the recommended frequency as a guideline.

Part	Replacement frequency
Mechanical Seal	When oil in oil compartment becomes milky.
Lubricant ; Turbine Oil VG32 (non-additive)	Every 6,000 hours or 12 month, whichever comes first.
Packing, O-Ring	Each time pump is disassembled or inspected.
Oil Seal	When ring is worn, and each time pump is disassembled or inspected
Shaft sleeve	When it becomes worn

8 DISASSEMBLY AND REASSEMBLY

WARNING

- Before disassembling the pump, first detach the Cabtyre Cable from the receptacle, after making certain the power supply (circuit breaker, etc.) is turned off. To avoid electrical shock, do not work with wet hands. Never check the operation of any parts (impeller rotation, etc.) by turning on the power while the unit is partially assembled. Failure to observe these precautions may result in serious accident.
- Do not disassemble or repair any parts other than those designated here. If repairs are necessary in any other than the designated parts, consult with your nearest dealer or Tsurumi representative. Improper repairs can result in electrical leakage, electrical shock, fire, or water leaks.
- After reassembly, always perform a test operation before resuming use of the pump. Improper assembly will cause the pump to malfunction, resulting in electrical shock or water leaks.

The procedure for disassembly and reassembly is shown here to the extent necessary for impeller replacement. A specialized environment and facilities are necessary for work in the mechanical seal and motor parts. Contact your nearest dealer or Tsurumi representative in the event such repairs are necessary.

Disassembly (KRS2-C6)

Note: *Remove the oil prior to disassembly.*

- (1) Removing the Bottom Plate and Strainer
Remove the Bottom Plate Hex. Nuts, then remove the Bottom Plate, Strainer from the pump.
- (2) Removing the Suction Cover
Remove the Hex. Bolts and Washers, remove the Stud Bolts and Plain Washers, then remove the Suction Cover and Packing from the Pump Casing.
- (3) Removing the Impeller
With a box wrench or other tool, remove the Impeller Nut, Spring Washer, and Impeller Thead Protect Cover, then remove the Impeller, Impeller Adjusting Washer, and Shaft Sleeve from the Shaft.

 **WARNING** A worn Impeller may have sharp edges that can cause injury, and should be handled with care.

Exploded View (KRS2-C6)

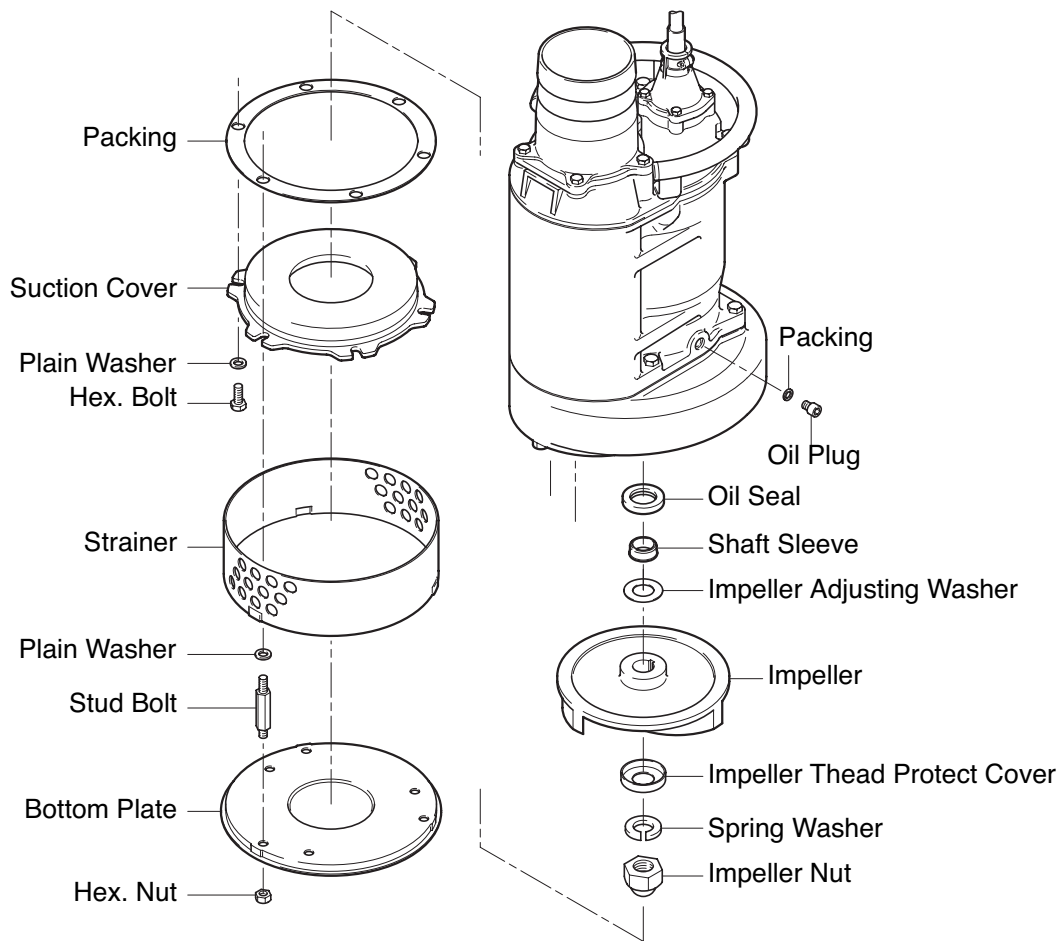

Note: *The above exploded view is for model KRS2-C6. Other models may differ slightly in shape and construction.*

Reassembly (KRS2-C6)

Reassembly can be performed by reversing the steps for disassembly, paying attention to the following precautions.

Note: *After assembling the pump, do not forget to fill it with Oil up to the required amount. Replace the Packing and O-Ring each time this operation is performed. Replace any other worn or damaged parts as well.*

After attaching the Impeller, and again after completing assembly, check to make sure the Impeller rotates smoothly and that it does not rub against the Suction Cover.

Impeller gap adjustment

Adjust the number of Impeller Adjusting Washers and the amount of Suction Cover Packing so that the gap between the Impeller and Suction Cover is from 0.3 to 0.5mm.

Disassembly (KRS1022)

Note: Remove the oil prior to disassembly.

- (1) Removing the Strainer Stand
Remove the Hex. Nuts and Spring Washers, then remove the Strainer Stand from the pump.
- (2) Removing the Suction Cover
Remove the Hex. Bolts and Spring Washers, remove the Stud Bolt, then remove the Suction Cover and Packing from the Pump Casing.
- (3) Removing the Impeller
Remove the Hex. Bolt, Impeller Nut, and Plain Washer, then remove the Impeller and the Oil Seal from the Shaft.

Exploded View (KRS1022)

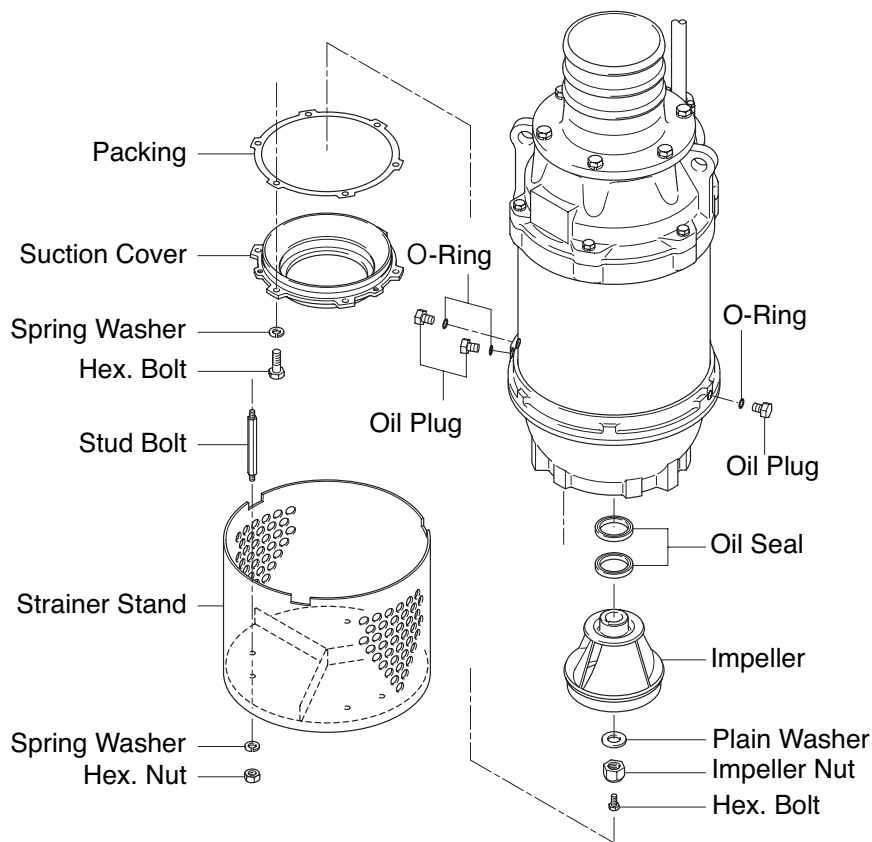

Note: The above exploded view is for model KRS1022. Other models may differ slightly in shape and construction.

Reassembly (KRS1022)

Reassembly can be performed by reversing the steps for disassembly, paying attention to the following precautions.

Note: After assembling the pump, do not forget to fill it with Oil up to the required amount. Replace the Packing and O-Ring each time this operation is performed. Replace any other worn or damaged parts as well.

After attaching the Impeller, and after attaching the Suction Cover, check to make sure the Impeller rotates smoothly and that it does not rub against the Pump Casing or Suction Cover.

9 TROUBLESHOOTING

 **WARNING** Always turn off the power before inspecting the pump. Failure to observe this precaution can result in serious accident.

Before ordering repairs, carefully read through this instruction manual, then repeat the inspection. If the problem remains, contact your nearest dealer or Tsurumi representative.

Problem	Possible causes	Countermeasure
Pump will not start	(1)Power is off. (2)Cabtyre cable is cut or not connected properly. (3)Impeller is clogged.	(1)Turn power on (2)Repair/replace the cable or fix the connection. (3)Inspect the pump and remove any debris.
Pump stops soon after starting (Motor protector operates)	(1)Impeller is clogged. (2)Low voltage. (3)Wrong power frequency. (4)Extended operation with a clogged strainer. (5)Faulty motor (burning, water infiltration, etc.). (6)Motor protection system was triggered.	(1)Remove debris. (2)Provide the rated voltage, or make sure the cabtyre cable extension is the proper standard. (3)Check the name plate, and replace the pump. (4)Remove debris from the strainer. (5)Repair or replace the motor. (6)If the pump is to be used for heavy liquid or other high loads, upgrade impeller.
Pool life or discharge capacity	(1)Worn out impeller. (2)Sharply bent or clogged hose. (3)Strainer stand clogged or buried. (4)Motor direction is reversed. (5)Wrong power frequency.	(1)Repair or replace the worn parts. (2)Straighten out any sharp bends. Enclose the pump with a screen to keep away debris. (3)Remove debris from the strainer stand, or place a block under the pump. (4)Interchange power supply leads as per p.11. (5)Check the name plate, and replace the pump.
Heavy vibration or noise	(1)Damaged motor shaft.	(1)Contact dealer and replace motor.

Disposal Product

Properly dispose of the product by disassembling it, presorting the contents, and sending them to the waste material treatment site.

The following information is required when ordering repairs or making other inquiries.

Product model	
Manufacturing number	
Purchase date	
Remarks	